

PARTS, OPERATION AND MAINTENANCE MANUAL for MANUAL CHAIN HOIST MODELS

SMB005
1/2 ton

SMB010
1 ton

SMB015
1-1/2 ton

SMB020
2 ton

SMB030
3 ton

SMB050
5 ton

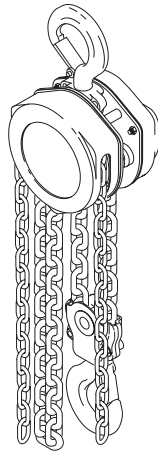

(Dwg. MHP0831)

Unless otherwise noted, tons in
this manual are metric tons.
1 metric ton = 2,200 lb.

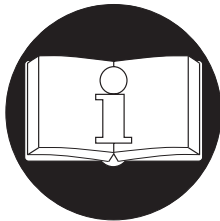

READ THIS MANUAL BEFORE USING THESE PRODUCTS. This manual contains important safety, installation, operation and maintenance information. Make this manual available to all persons responsible for the operation, installation and maintenance of these products.

⚠ WARNING

Do not use this hoist for lifting, supporting, or transporting people or lifting or supporting loads over people.

Always operate, inspect and maintain this hoist in accordance with American Society of Mechanical Engineers Safety Code (ASME B30.16) and any other applicable safety codes and regulations.

Refer all communications to the nearest Ingersoll Rand Office or Distributor.

SAFETY INFORMATION

This manual provides important information for all personnel involved with the safe installation, operation and proper maintenance of this product. Even if you feel you are familiar with this or similar equipment, you should read this manual before operating the product.

Danger, Warning, Caution and Notice

Throughout this manual there are steps and procedures which, if not followed, may result in a hazard. The following signal words are used to identify the level of potential hazard.



DANGER

Indicates an imminently hazardous situation which, if not avoided, will result in death or serious injury.



WARNING

Indicates a potentially hazardous situation which if not avoided, could result in death or serious injury.



CAUTION

Indicates potentially hazardous situation which if not avoided, may result in minor or moderate injury or property damage.

NOTICE

Indicates information or a company policy that relates directly or indirectly to the safety of personnel or protection of property.

The words shall and should are used throughout this manual in accordance with definitions in the ASME B30 standards as follows:

Shall - this word indicates that the requirement is mandatory and must be followed.

Should - this word indicates that the requirement is a recommendation. The advisability of the recommendation depends on the facts in each situation.

Also used in this manual and other manuals are the following words with definitions:

Owners/users - these words also refer to winch operators.

Signal-person - person who observes load and relays directions to winch operator.

Operation Manuals - documentation that is provided with the winch that contains installation, parts information, maintenance, lubrication and related service instructions.

Safety Summary



WARNING

• **Do not use this hoist for lifting, supporting, or transporting people or lifting or supporting loads over people.**

The National Safety Council, Accident Prevention Manual for Industrial Operations, Eighth Edition and other recognized safety sources make a common point: Employees who work near cranes or assist in hooking on or arranging a load should be instructed to keep out from under the load. From a safety standpoint, one factor is paramount: conduct all lifting operations in such a manner that if there were an equipment failure, no personnel would be injured. This means keep out from under a raised load and keep out of the line of force of any load.

Ingersoll Rand hoists are manufactured in accordance with the latest ASME B30.16 standards.

The Occupational Safety and Health Act of 1970, generally places the burden of compliance with the user, not the manufacturer. Many OSHA requirements are not concerned or connected with the manufactured product but are, rather, connected with the final installation. It is the owner's and user's responsibility to determine the suitability of a product for any particular use. It is recommended that all applicable industry, trade association, federal, state and local regulations be checked. Read all operating instructions and warnings before operation.

Rigging: It is the responsibility of the operator to exercise caution, use common sense and be familiar with proper rigging techniques. Refer to ASME B30.9 for rigging information, American Society of Mechanical Engineers, Three Park Avenue, New York, NY 10016.

SAFE OPERATING INSTRUCTIONS

The following warnings and operating instructions have been adapted in part from American Society of Mechanical Engineers ASME B30.16 (Overhead Hoists) and are intended to avoid unsafe operating practices which might lead to injury or property damage.

Ingersoll Rand recognizes that most companies who use hoists have a safety program in force in their facilities. In the event that some conflict exists between a rule set forth in this publication and a similar rule already set by an individual company, the more stringent of the two should take precedence.

Safe Operating Instructions are provided to make an operator aware of unsafe practices to avoid and are not necessarily limited to the following list. Refer to specific sections in the manual for additional safety information.

1. Only allow people, trained in safety and operation of this product, to operate the hoist.

2. Only operate a hoist if you are physically fit to do so.
3. When a **“DO NOT OPERATE”** sign is placed on the hoist, do not operate the hoist until the sign has been removed by designated personnel.
4. Before each shift, the operator should inspect the hoist for wear or damage.
5. Never use a hoist which inspection indicates is worn or damaged.
6. Periodically, inspect the hoist thoroughly and replace worn or damaged parts. Refer to the **“INSPECTION”** section on page 5.
7. Lubricate the hoist regularly. Refer to the **“LUBRICATION”** section on page 7.
8. Do not use hoist if hook latch has been sprung or broken.
9. Check that the hook latches are engaged before using.
10. Never splice a hoist chain by inserting a bolt between links.
11. Only lift loads less than or equal to the rated capacity of the hoist. Refer to the **“SPECIFICATIONS”** section on page 3.

12. When using two hoists to suspend one load, select two hoists each having a rated capacity equal to or more than the load. This provides adequate safety in the event of a sudden load shift.
13. Never place your hand inside the throat area of a hook.
14. Never use the hoist load chain as a sling.
15. Never operate a hoist when the load is not centered under the hook. Do not “side pull” or “yard.”
16. Never operate a hoist with twisted, kinked, “capsized” or damaged load chain.
17. Do not force a chain or hook into place by hammering.
18. Never insert the point of the hook into a chain link.
19. Be certain the load is properly seated in the saddle of the hook and the hook latch is engaged.
20. Do not support the load on the tip of the hook.
21. Never run the load chain over a sharp edge. Use a sheave.
22. Pay attention to the load at all times when operating the hoist.
23. Always ensure that you, and all other people, are clear of the path of the load. Do not lift a load over people.
24. Never use the hoist for lifting or lowering people, and never allow anyone to stand on a suspended load.
25. Ease the slack out of the chain and sling when starting a lift. Do not jerk the load.
26. Do not swing a suspended load.
27. Never weld or cut on a load suspended by the hoist.
28. Never use the hoist chain as a welding electrode.
29. Do not operate hoist if chain jumping, excessive noise, jamming, overloading, or binding occurs.
30. Only operate the hoist with manual power.
31. After use, or when in a non-operational mode, the chain hoist should be secured against unauthorized and unwarranted use.
32. Do not leave a load suspended when the hoist is unattended or not in use.

WARNING TAG

Each hoist is supplied from the factory with a multi-language warning tag. If the tag is not attached to your unit, order a new tag and install it. Refer to the parts list for the part number. Read and obey all warnings and other safety information attached to this hoist. Tag may be shown smaller than actual size.

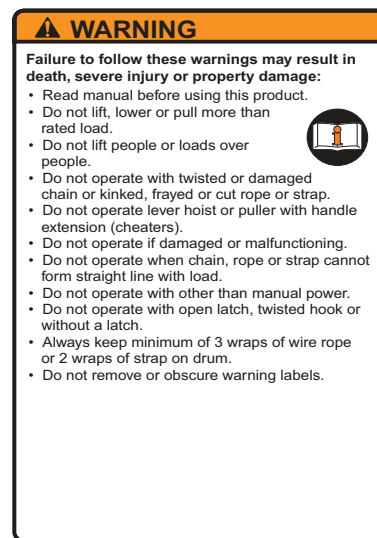

SPECIFICATIONS

General

Manual Chain Hoists can be mounted to the suspension shaft of a trolley or a permanent mounting structure. The hoist is designed to lift and lower loads up to rated capacity with minimal hand chain effort.

To determine your basic hoist configuration, refer to capacity and lot number label located on gear end cover for model number information.

Model Code Explanation

Example:	SMB - 005 - 10 - 8 V
Series	
Capacity	
Lift	
Hand Chain	
Slip Clutch	

Series	Hoist Capacity	Lift (Hoist load chain/ hook travel)	Hand Chain (Hand chain is 2 ft less than lift)	Slip Clutch
SMB= Silver Series Manual Chain Hoist	005 = 1/2 metric ton / 500 kg 010 = 1 metric ton / 1,000 kg 015 = 1-1/2 metric ton / 1,500 kg 020 = 2 metric ton / 2,000 kg 030 = 3 metric ton / 3,000 kg 050 = 5 metric ton / 5,000 kg	10 = 10 ft (3 m) (standard) 15 = 15 ft (5 m) 20 = 20 ft (6 m) XX = Specify length F = Hoist without load chain	8 = 8 feet (standard) (10 foot lift minus 2 ft) 13 = 13 feet (15 foot lift minus 2 ft) 18 = 18 feet (20 foot lift minus 2 ft) XX = Specify length	V = Slip Clutch (standard)

General Specifications

Model No.	Rated Capacity (metric tons)*	Pull to Lift Rated Load		Load Chain Size (mm)	Hand Chain Overhauled to Lift Load 1 ft (0.3 m)		No. of Chain Falls	Hoist Net Weight with Standard 10 ft (3 m) Lift	
		lb	kg		ft	m		lb	kg
SMB005	1/2	55.5	25	5 x 15	31.5	9.6	1	23.5	10.7
SMB010	1	64	29	6 x 18	53.1	16		26.8	12.2
SMB015	1-1/2	69	31	7 x 21	71.6	22		38.5	17.5
SMB020	2	77	35	8 x 24	84.6	26	1	42.4	19.3
SMB030	3	100	45	10 x 30	99.4	30		70.4	32
SMB050	5	83.5	38	9 x 27	213.2	65		90.2	41

* One metric ton = 2,200 lbs.

INSTALLATION

Prior to installing the hoist, carefully inspect it for possible shipping damage.

Hoists are supplied fully lubricated from the factory. Lubrication of the load chain is recommended before initial hoist operation.

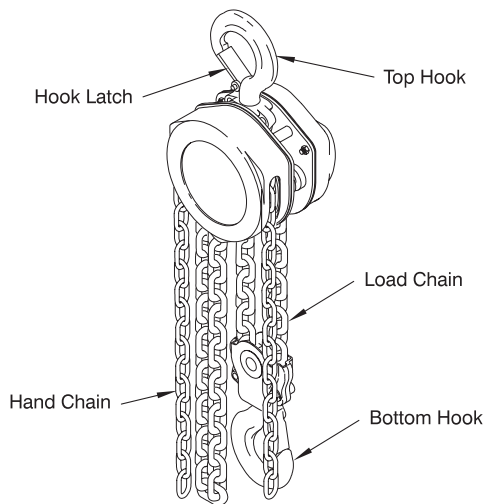

(Dwg. MHP0832)

WARNING

• A falling load can cause injury or death. Before installing, read “SAFETY INFORMATION”.

CAUTION

• Owners and users are advised to examine specific, local or other regulations, including American Society of Mechanical Engineers and/or OSHA Regulations which may apply to a particular type of use of this product, before installing or putting hoist to use.

Hoists are designed to provide a 4:1 safety factor. The supporting structures and load-attaching devices used in conjunction with this hoist must provide adequate support to handle all hoist operations, plus the weight of the hoist and attached equipment. If in doubt, consult a registered structural engineer.

The SMB manual chain hoist must be used in a vertical position to provide a straight line pull from top hook to bottom hook. The hoist must be positioned so that it does not contact the support members when in use. When operating in limited areas suitable lifting attachments or slings must be used to prevent the hoist body and hand chain from being obstructed.

Initial Operating Checks

CAUTION

- **Ensure the hoist top hook is properly installed on the support member and the hook latch is engaged.**

Operate the hoist with a test load (10% of rated capacity) by raising and lowering this load several times. Verify the brake operation by lowering the same load to check load does not slip when lowering stops.

NOTICE

- **Each time a load is lifted, the operation of the load brake should be checked by raising the load slightly and stopping to ensure the brake will hold the load before proceeding to lift the load.**

Familiarize operators and people responsible for hoist installation and service with ASME B30.16 specifications prior to placing the unit into service. All the requirements of this specification, including testing should be met before approving the hoist for operation.

OPERATION

The four most important aspects of hoist operation are:

1. Follow all safety instructions when operating the hoist.
2. Allow only personnel trained in safety and operation of this hoist to operate hoist.
3. Subject each hoist to a regular inspection and maintenance procedure.
4. Be aware of hoist capacity and weight of load at all times.

WARNING

- **Hoist is not designed or suitable for lifting, lowering or moving persons. Never lift loads over people.**

Hoist Operation

When facing hand chain side of hoist:

1. Pull down on the right hand chain (clockwise) to raise load.
2. Pull down on the left hand chain (counterclockwise) to lower load.

NOTICE

- **The clicking sound of the pawl on the ratchet gear is normal when a load is being raised.**

Slip Clutch Operation

Hoists are equipped with a slip clutch. When trying to lift a load that exceeds capacity of hoist the hand chain will rotate in the hoist body but the load will not be lifted.

It is important to keep the slip clutch properly adjusted. Refer to the “MAINTENANCE” section on page 8 for the proper procedure.

Storing the Hoist

1. Always store hoist in a no load condition.
2. Wipe off all dirt and water.
3. Oil the chain, hook pins and hook latch pins.
4. Hang in a dry place.
5. Before returning hoist to service follow instructions for “Hoists Not in Regular Use” in the “INSPECTION” section on page 5.

INSPECTION

WARNING

- **All new, altered or modified hoists should be inspected and tested by personnel trained in safety, operation and maintenance of this hoist to ensure safe operation at rated specifications before placing hoist in service.**

Frequent and periodic inspections should be performed on hoists in regular service. Frequent inspections are visual examinations performed by operators or service personnel and include observations made during routine hoist operation. Periodic inspections are thorough inspections conducted by personnel trained in the safety, operation and maintenance of this hoist. ASME B30.16 states inspection intervals depend upon the nature of the critical components of the hoist and the severity of usage.

Careful inspection on a regular basis will reveal potentially dangerous conditions while still in the early stages, allowing

corrective action to be taken before the condition becomes dangerous.

Deficiencies revealed through inspection, or noted during operation, must be reported to designated personnel trained in safety, operation and maintenance of this hoist. A determination as to whether a condition constitutes a safety hazard must be decided, and the correction of noted safety hazards accomplished and documented by written report before placing the hoist in service.

Records and Reports

Inspection records, listing all points requiring periodic inspection should be maintained for all load bearing equipment. Written reports, based on severity of service, should be made on the condition of critical parts as a method of documenting **periodic** inspections. These reports should be dated, signed by the person who performed the inspection, and kept on file where they are readily available for review.

Load Chain Reports

Records should be maintained documenting the condition of load chain removed from service as part of a long-range load chain inspection program. Accurate records will establish a relationship between visual observations noted during frequent inspections and the actual condition of the load chain as determined by periodic inspection methods.

Frequent Inspection

Manual Chain Hoists should be inspected at the beginning of each shift. Visual inspections should also be conducted during regular service for any damage or evidence of malfunction which appears between regular inspections.

1. **Operation.** Check for visual signs or abnormal noises which could indicate a potential problem. Do not operate a hoist unless the load chain feeds through the hoist and hook block smoothly. Listen for “clicking”, binding or malfunctioning. The clicking sound of the pawl on the ratchet gear is normal when a load is being raised. If chain binds, jumps, or is excessively noisy, clean and lubricate the chain. If problem persists, the chain and load sheave may have to be replaced. Do not operate the hoist until all problems have been corrected. Check that hand chain moves freely without binding or excessive drag. Load chain travel should stop when hand chain stops moving.
2. **Hooks.** Check for wear or damage, increased throat width, bent shank or twisting of hook. Replace hooks which exceed the throat opening discard width (15%) shown in Table 1 (refer to Dwg. MHP0040 on page 6) or exceed a 10° twist (refer to Dwg. MHP0111 on page 6). If the hook latch snaps past the tip of the hook, the hook is sprung and must be replaced. Check hooks swivel easily and smoothly. Repair or lubricate as necessary.

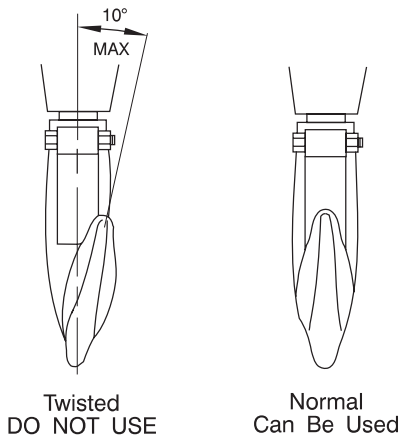

(Dwg. MHP0111)

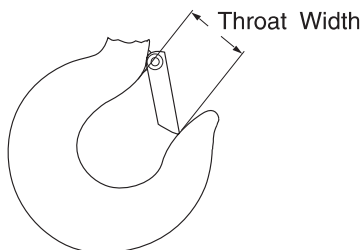

(Dwg. MHP0040)

Table 1: Hook Throat Opening

Model No.	Normal		Discard	
	in	mm	in	mm
SMB005	0.94	24	1.09	27.6
SMB010	1.00	26	1.18	30
SMB015	1.10	33	1.50	38
SMB020				
SMB030	1.50	39	1.76	44.8
SMB050	1.89	48	2.17	55.2

3. **Hook Latches.** Check operation of the hook latches. Replace if broken or missing.
4. **Chain.** Refer to Dwg. MHP0102 on page 6. Examine each link for bending, cracks in weld areas or shoulders, transverse nicks and gouges, weld splatter, corrosion pits, striation (minute parallel lines) and chain wear, including bearing surfaces between chain links. Replace a chain that fails any of the inspections. Check lubrication and lubricate if necessary. Refer to “Load Chain” in “LUBRICATION” section on page 7.

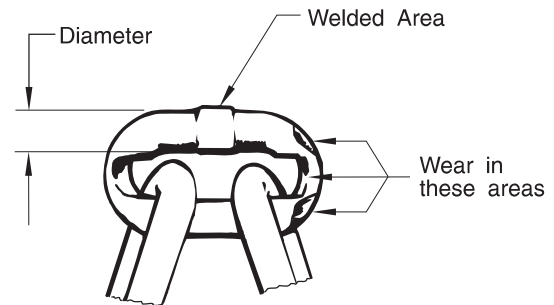

(Dwg. MHP0102)

CAUTION

- The full extent of chain wear cannot be determined by visual inspection. At any indication of chain wear, inspect chain and load sheave in accordance with instructions in “Periodic Inspection.”
- A worn load chain may cause damage to the load sheave. Inspect the load sheave and replace if damaged or worn.

5. **Load Chain Reeving.** Refer to Dwg. MHP0042 on page 9. Make sure welds on standing links are away from load sheave. Reinstall chain if necessary. Check that the last link of the load chain is securely connected. On 2, 3 and 5 ton hoists, make sure chain is not capsized, twisted or kinked. Adjust as required.

Periodic Inspection

According to ASME B30.16, frequency of periodic inspection depends on the severity of usage:

NORMAL	HEAVY	SEVERE
yearly	semiannually	quarterly

Disassembly may be required for HEAVY or SEVERE usage. Keep accumulative written records of periodic inspections to provide a basis for continuing evaluation. Inspect all items in “Frequent Inspection”. Also inspect the following:

1. **Fasteners.** Check rivets, capscrews, nuts, cotter pins and other fasteners on hooks and hoist body. Replace if missing and tighten or secure if loose.
2. **All Components.** Inspect for wear, damage, distortion, deformation and cleanliness. If external evidence indicates the need, disassemble. Check gears, shafts, bearings, sheaves, chain guides, springs and covers. Replace worn or damaged parts. Clean, lubricate and reassemble.
3. **Hooks.** Inspect hooks for cracks. Use magnetic particle or dye penetrant to check for cracks. Inspect hook retaining parts. Tighten, repair or replace if necessary. Refer to the latest edition of ASME B30.10 (Hooks) for additional hook inspection information.
4. **Chain Sheaves.** Check for damage or excessive wear. Replace if necessary.
5. **Brake.** Ensure proper operation. Brake must hold hoist rated capacity. If load test indicates the need, disassemble. Brake discs must be free of oil, any grease, unglazed and uniform in thickness. Refer to "MAINTENANCE" section for allowable brake disc wear. Check all other brake surfaces for wear, deformation or foreign deposits. Inspect gear teeth, pawl and pawl spring for damage. Check that brake pawl stops counterclockwise rotation of ratchet gear. Clean and replace damaged components as necessary.
6. **Supporting Structure.** If a permanent structure is used, inspect for continued ability to support load.
7. **Labels and Tags.** Check for presence and legibility. Replace if necessary.
8. **End Anchor.** Ensure end anchor is installed and unbent. Replace if missing or damaged. Refer to "Attaching End of Load Chain" in the "MAINTENANCE" section.
9. **Load Chain.** Measure the chain for stretching by measuring across five link sections all along the chain length. Refer to Dwg. MHP0041 on page 7. When any five links in the working length reach or exceed the discard length shown in Table 2, replace the entire chain. Always use a genuine **Ingersoll Rand** replacement chain.

Table 2: Load Chain Length Inspection

Model No.	Chain Size	Normal Length		Discard Length	
	mm	in	mm	in	mm
SMB005	5 x 15	2.95	75	3.03	77
SMB010	6 x 18	3.54	89.9	3.63	92.2
SMB015	7 x 21	4.17	106	4.28	108.7
SMB020	8 x 24	4.72	119.9	4.84	122.9
SMB030	10 x 30	5.91	150.1	6.03	153.2
SMB050	9 x 27.2	5.35	136	5.47	139

Hand Chain: No "discard" length needed.

(Dwg. MHP0041)

Hoists Not in Regular Use

1. Hoists which have been idle for a period of one month or more, but less than one year should be given an inspection conforming with the requirements of "Frequent Inspection" before being placed in service.
2. Hoists which have been idle for a period of over one year should be given a complete inspection conforming with the requirements of "Periodic Inspection" before being placed in service.
3. Standby hoists should be inspected at least semiannually in accordance with the requirements of "Frequent Inspection".

LUBRICATION

General

Thread lubricant or an antiseize compound use is recommended for threaded shafts, capscrews and nuts. Unless otherwise stated, remove old lubricant, clean the part with an acid free solvent and apply a new coating of lubricant to the part before assembly.

Gears (38 and 41)

1. Remove nuts on gear cover.
2. Remove old grease and replace with new. For temperatures -20° to 50° F (-29° to 10° C) use EP 1 grease or equivalent. For temperatures 30° to 120° F (-1° to 49° C) use EP 2 grease or equivalent.

Load Chain

WARNING

• **Failure to maintain clean and well lubricated load chain may result in chain failure causing injury, death or substantial property damage.**

1. Lubricate each link of the load chain weekly. Apply new lubricant over existing layer.
2. In severe applications or corrosive environments, lubricate more frequently than normal.
3. Lubricate hook and hook latch pivot points with the same lubricant used on the load chain.
4. To remove rust or abrasive dust build-up, clean chain with acid free solvent. After cleaning, lubricate the chain.
5. Use **Ingersoll Rand** LUBRI-LINK-GREEN®.

TROUBLESHOOTING

This section provides basic troubleshooting information. Specific causes to problems are best identified by thorough inspections performed by personnel instructed in safety, operation and maintenance of this equipment. The chart below provides a brief guide to common hoist symptoms, probable causes and remedies.

	CAUSE	REMEDY
Hoist will not operate.	Hoist is overloaded.	Reduce load to within rated capacity.
	Slip clutch not adjusted.	Adjust slip clutch. Refer to "MAINTENANCE" section.
Load continues to move when hoist is stopped.	Brake is slipping.	Check brake adjustment and brake disc wear. Check brake discs are clean.
	Hoist is overloaded.	Reduce load to within rated capacity.
Load chain binds.	Damaged load chain, pinion shaft, gears or sheaves.	Disassemble hoist, inspect and repair or replace damaged components. Refer to "MAINTENANCE" section.
	Load chain not installed properly (twisted, kinked or "capsized")	Remove load chain and reinstall.
Hand chain binds.	Damaged hand chain, hand chain wheel, pinion shaft, gears, load chain, sheaves.	Disassemble hoist, inspect and repair or replace damaged components.
	Hand chain not installed properly (twisted or kinked).	Remove hand chain and reinstall.
Load hook latch does not work.	Latch broken.	Replace hook latch.
	Load hook bent or twisted.	Inspect load hook as described in "INSPECTION" section. Replace if necessary.

MAINTENANCE

⚠ WARNING

- Never perform maintenance on the hoist while it is supporting a load.
- Before performing maintenance, tag hoist:
DANGER - DO NOT OPERATE - EQUIPMENT BEING REPAIRED.
- Only allow personnel trained in the operation and service of this product to perform maintenance.
- After performing maintenance on the hoist, test to 125% of its rated capacity before returning to service. Testing to 150% of rated capacity will be required to set overload clutch and might be required to comply with standards and regulations set forth in areas outside of the USA.

Installing New Load Chain

⚠ WARNING

- To prevent a falling load, which can cause death, injury or property damage, the hook must be on left fall of load chain and right fall must be attached to hoist body with anchor pin and anchor hanger. Right and left designations are as viewed from the hand chain side of the hoist.

NOTICE

- Do not remove the old load chain from the hoist. The old load chain can be used to install the new load chain.

1. Remove end of load chain from anchor pin.
 - a. 1/2 to 3 ton units are single fall hoists. The load end of the load chain is anchored to the bottom hook assembly. To disconnect the load chain from the bottom hook assembly remove anchor pin and nut. On bottom hook remove spring and pin.
 - b. 5 ton units are double chain fall hoists. The load end of the load chain is anchored to suspension plates. To disconnect load chain from suspension plates remove anchor bolt assembly.
2. Make a "C" link in new load chain by grinding through one side of the end link. Refer to Dwg. MHP0817 on page 8. To avoid twisting, the load chain on 2, 3 and 5 ton units must have an odd number of links, not counting the "C" link.

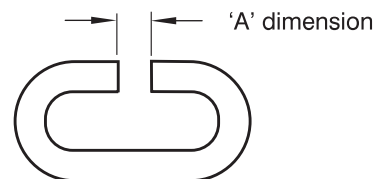

"C" Link

(Dwg. MHP0817)

- Using a “C” link, join the old load chain to the new load chain. (If the old load chain was installed correctly, the “C” link assures end link of new load chain will be correctly reeved through the hoist.) Be sure welds of “standing” links on the new load chain are facing away from the hoist load sheave. Refer to Dwg. MHP0042 on page 9.

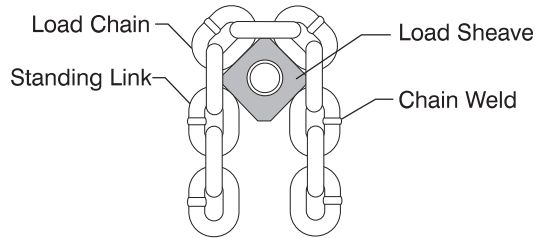

(Dwg. MHP0042)

- Run the new chain to its anchor point. On smaller units, use the hand chain to move the load chain. On larger units, load chain installation can be speeded up by removing gear cover, support plate and taking out gears. With the gears removed, the load chain can be pulled by hand through the hoist body and hook blocks. Reinstall gears, support plate, and gear cover.
- Remove “C” link and old chain.
- On 1/2, 1 and 1-1/2 ton hoists, anchor load chain to bottom hook assembly. On 2, 3 and 5 ton units, secure load chain to suspension plates using anchor bolt assembly.

For information on connecting unloaded end of load chain, refer to ‘Attaching End of Load Chain’ section.

- Check for the following:
 - Load chain did not become twisted, when reeving the load chain between the idler sheave on the bottom hook assembly and the hoist load sheave. Refer to Dwg. MHP0020 on page 9.
 - Make sure load chain is reeved between load sheave and chain guides.

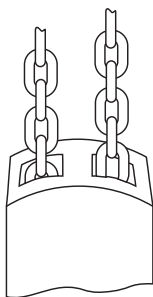

Appearance of chain that is Not Twisted

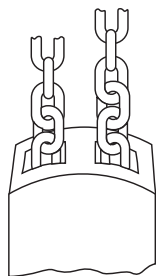

Appearance of chain that is Twisted

(Dwg. MHP0020)

Slip Clutch

The slip clutch is designed to slip, (handwheel rotates but no load chain movement), when attempting to lift a load greater than the capacity of the hoist. To adjust the slip clutch you will need a weight that is known to be 150% of hoist capacity or a scale that will read at least 150% of hoist capacity. Attach hoist to a suitable support and then attach load/scale to load hook.

Adjusting with a Weight

- Remove handwheel cover from hoist.
- Using hand chain ‘hoist up’ the load. If load does not rise tighten nut 1/4 turn. Attempt to raise the load. Continue tightening nut in 1/4 turn increments until load raises.
- Then lower the load and back the nut off 1/4 turn. The slip clutch is now adjusted.
- Reinstall handwheel cover to hoist.

Adjusting with a Scale

- Remove handwheel cover from hoist.
- Using hand chain, ‘hoist up’. Needle on scale should only go up to 150% of hoist capacity, then the clutch will slip.
- If clutch slips prior to 150% capacity, ‘hoist down’ (to remove tension) and tighten nut 1/4 turn. Continue this ‘hoist up’, ‘hoist down’ procedure, adjusting the nut in 1/4 turn increments, until the scale reads 150% of rated load. The slip clutch is now adjusted.
- Reinstall handwheel cover to hoist.

NOTICE

• Due to the nature of the design, an exact precision clutch setting may be difficult to obtain. Repeated slipping of the clutch, in an attempt to obtain an exact setting may reduce the life of clutch components.

Attaching End of Load Chain

- Remove cotter pin from anchor hanger. Push anchor pin into one of the side plates.
- Position end link of load chain on anchor pin.
- Reposition anchor pin to engage both side plates.
- Install cotter pin in anchor pin on either side of load chain and bend ends apart.

On 2, 3 and 5 ton hoists, ensure load chain is not twisted, kinked or “capsized”. Refer to Dwg. MHP0043 on page 9.

Capsized Hook

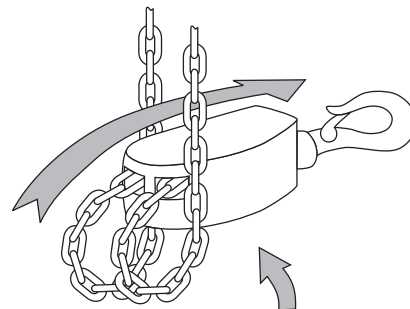

Make certain the bottom block has NOT been flipped through the chain falls

(Dwg. MHP0043)

General Disassembly

The following instructions provide the necessary information to disassemble, inspect, repair, and assemble the hoist. Parts drawings of the hoist assembly are provided in the parts section. If a hoist is being completely disassembled for any reason, follow the order of the topics as they are presented. It is recommended that all maintenance work on the hoist be performed on a bench.

In the process of disassembling the hoist, observe the following:

1. Never disassemble the hoist any further than is necessary to accomplish the needed repair. A good part can be damaged during the course of disassembly.
2. Never use excessive force when removing parts. Tapping gently around the perimeter of a cover or housing with a soft hammer, for example, is sufficient to break the seal.
3. Do not heat a part with a flame to free it for removal, unless the part being heated is already worn or damaged beyond repair and no additional damage will occur to other parts. In general, the hoist is designed to permit easy disassembly and assembly. The use of heat or excessive force should not be required.
4. Keep the work area as clean as practical, to prevent dirt and other foreign matter from getting into bearings or other moving parts.
5. When grasping a part in a vise, always use leather-covered or copper-covered vise jaws to protect the surface of the part and help prevent distortion. This is particularly true of threaded members, machined surfaces and housings.
6. Do not remove any part which is press fit in or on a subassembly unless the removal of that part is necessary for repairs or replacement.

Disassembly

Accessing Gear End

1. Remove the three nuts from gear cover.
2. Remove gear cover.
3. Remove nuts along with lockwashers from support plate.
4. Remove support plate, gears and bearings.
5. Remove retainer ring from load sheave and pry off gear.

Accessing Brake End

1. Remove the three nuts and screws from handwheel cover.
2. Remove handwheel cover.
3. Remove cotter pin and nut from pinion shaft.
4. Secure load sheave to prevent rotation and unscrew handwheel from pinion shaft. Handwheel is left hand (counterclockwise) threaded.
5. Remove brake discs and ratchet disc.
6. Secure load sheave to prevent rotation and unscrew brake hub from pinion shaft.

NOTICE

• If ratchet pawls or springs are damaged or not functioning then remove retainer ring and replace damaged parts.

Slip Clutch Disassembly

1. Remove cotter pin and nut.
2. Pull handwheel/slip clutch assembly off of pinion shaft.
3. Remove nut from support and separate support, spring and single cone.
4. Remove screws and carefully pry double cone off of handwheel.

Accessing Load Sheave

Follow steps 1 through 5 in 'Accessing Gear End' and steps 1 through 6 in 'Accessing Brake End', then steps below.

1. Remove nuts and lockwashers from side plate.
2. Pull side plate away from studs in side plate.
3. Remove the top hook assembly, roller bearings, two-chain guides, chain stripper, and anchor hanger.
4. Lift load sheave from side plate. Being careful to catch roller bearings as they become free.

Bottom Hook Disassembly (2, 3 and 5 ton)

1. Remove three capscrews, lockwashers and nuts.
2. Separate plates and remove hook.
3. Lift out sheave assembly. Carefully slide idler sheave shaft from idler sheave and remove rollers.

Cleaning, Inspection and Repair

Use the following procedures to clean and inspect the components of the hoist.

Cleaning

Clean all hoist component parts in an acid free solvent (except for the brake disc). The use of a stiff bristle brush will facilitate the removal of accumulated dirt and sediments on the gears and frames. Dry each part using low pressure, filtered compressed air.

Inspection

All disassembled parts should be inspected to determine their fitness for continued use. Pay particular attention to the following:

1. Inspect all gears for worn, cracked, or broken teeth.
2. Inspect shafts for ridges caused by wear. If ridges caused by wear are apparent on shafts, replace the shaft.
3. Inspect all threaded items and replace those having damaged threads.
4. Measure the thickness of the brake discs. If brake discs do not have uniform thickness or are less than the discard dimension shown in Table 3: Brake Disc Chart, replace brake discs.

Table 3: Brake Disc Chart

	1/2 - 5 ton	
	in	mm
Normal	0.10	2.5
Discard	0.075	1.875

5. Inspect ratchet pawls and springs on side plate assembly. Replace parts if pawls and or springs are damaged or fail to operate.

Repair

Actual repairs are limited to the removal of small burrs and other minor surface imperfections from gears and shafts. Use a fine stone or emery cloth for this work.

1. Worn or damaged parts must be replaced. Refer to the applicable parts listing for specific replacement parts information.
2. Inspect all remaining parts for evidence of damage. Replace or repair any part which is in questionable condition. The cost of the part is often minor in comparison with the cost of redoing the job.
3. Smooth out all nicks, burrs, or galled spots on shafts, bores, pins, and bushings.
4. Examine all gear teeth carefully, and remove nicks and burrs.
5. Polish the edges of all shaft shoulders to remove small nicks which may have been caused during handling.
6. Remove all nicks and burrs caused by lockwashers.

Assembly

Load Sheave Assembly

1. Apply grease to roller bearings and position them in the groove of the bearing race located on the gear end of the load sheave.
2. Install load sheave in side plate, ensure roller bearings remain in position.
3. Install two-chain guides, chain stripper assembly, anchor hanger assembly, and top hook assembly in side plate.
4. Apply grease to the second set of roller bearings and position them in groove of the bearing race located on the plain end of the load sheave. The same number of roller bearings must be used on either side of the load sheave.
5. Carefully install side plate assembly to engage the locating diameters of parts installed in steps 3 and 4. Ensure all roller bearings remain in position.
6. Install lockwashers and nuts and tighten.

Slip Clutch Assembly

1. Place double cone onto pins in handwheel and press until seated.
2. Insert screws through double cone and tighten.
3. Insert single cone into double cone along with spring.
4. Insert support through backside of double cone. Thread nut onto support loosely.
5. Slide this assembly onto pinion shaft and secure with nut and cotter pin.
6. Refer to 'Adjusting Slip Clutch' for adjustment procedures.

Gear End Assembly

Follow steps 1 through 6 described in 'Load Sheave Assembly'.

1. Install gear on load sheave. Ensure recessed side of gear face is outward. Install retainer ring on load sheave to secure gear.
2. Install pinion shaft through the center of load sheave.
3. Install gears so gear teeth are correctly timed and end shafts are located in bearing sleeves in side plate. Refer to 'Gear Timing' section on page 11.
4. Apply a thick coat of grease as recommended in the "LUBRICATION" section to all gear teeth. Install support plate over gears to engage gear end shafts.
5. Secure support plate with nuts and lockwashers.
6. Install the gear cover. Secure with three nuts and screws.

Brake End Assembly

Follow steps 1 through 6 described in 'Load Sheave Assembly' and steps 1 through 6 described in 'Gear End Assembly', then below steps.

CAUTION

• **The brake will not operate properly if there is oil on the brake discs.**

1. Thread brake hub onto pinion shaft until snug. Stepped side of brake hub must face out.
2. Install first brake disc followed by ratchet disc and second brake disc. Ratchet disc teeth must engage the two pawls mounted on side plate assembly. Counterclockwise rotation of the ratchet disc must be possible.
3. Secure load sheave to prevent rotation and thread handwheel onto pinion shaft and secure with nut. Tighten nut until snug and then back nut off until first slot is aligned with pin hole in pinion shaft. Install cotter pin and bend ends apart.
4. Wrap hand chain around handwheel and feed ends through slots provided in hand chain wheel cover. Install the handwheel cover. Secure with three nuts and screws.

Bottom Hook Assembly (2, 3 and 5 ton hoists only)

1. Grease and install the rollers in the groove provided in the bore of the idler sheave.
2. Install idler sheave shaft through the idler sheave bore. Ensure rollers remain in position.
3. Carefully place the assembled parts between the plates.
4. Install hook between plates and clamp plate halves together with capscrews, lockwashers and nuts.

Gear Timing

For proper operation, timing marks on the gears must be in the correct positions. The timing marks are circular impressions on the faces of gears. Refer to Dwg. MHP0833 on page 11.

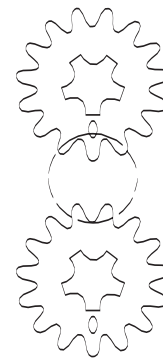

All Models

(Dwg. MHP0833)

Hand Chain Adjustment or Replacement

CAUTION

• When cutting the weld side of a hand chain link, do not cut or nick the opposite side. A damaged link must be replaced to prevent premature failure. A falling hand chain can cause injury.

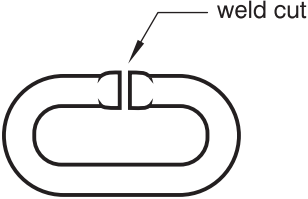

'C' Link

(Dwg. MHP0016)

1. To create a "C" link, cut the welded side of the link with a hack saw. Clamp one side of the "C" link in a vise and bend it open by using a pliers to grip the exposed part of the link.

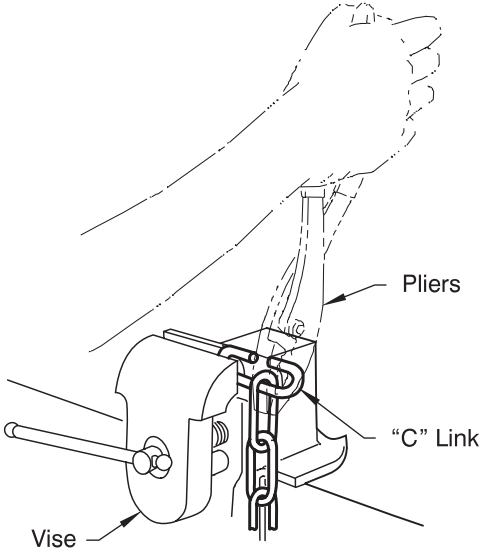

(Dwg. MHP0014)

2. If the hand chain is being replaced, disconnect it at the "C" link and carefully remove the hand chain.
3. When replacing a hand chain, cut a length 2 times the required hand chain drop plus about one foot (305 mm). For adjustments, remove or add a length of chain twice the difference in hand chain height. To prevent the hand chain from twisting, maintain an even number of links, by removing or adding an even number of links.
4. If you are replacing the hand chain, run the new hand chain up through the left hand chain guide, around the handwheel, making sure the hand chain is seated in the handwheel pockets, and back down through the right hand chain guide.
5. Connect the hand chain ends with the "C" link(s), making the total number of links even, and bend the "C" link(s) shut.
6. Make sure the hand chain is not twisted. If twisted, untwist or open a "C" link and remove one hand chain link. Refer to Dwg. MHP0015 on page 12.

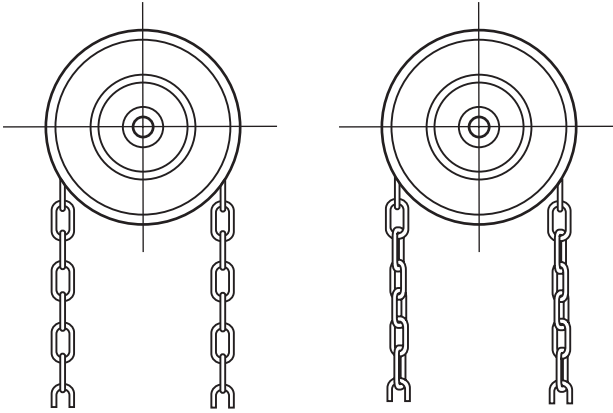

Untwisted

Twisted
Do Not Use

(Dwg. MHP0015)

Load Test

Prior to initial use, all new, extensively repaired, or altered hoists shall be load tested by or under the direction of a person trained in the operation and maintenance of this hoist, and a written report furnished confirming the rating of the hoist. Test hoist to 125% of the rated hoist capacity. Testing to more than 125% will be required to set overload clutch and may be necessary to comply with standards and regulations set forth in areas outside of the USA.

SERVICE NOTES

HOIST ASSEMBLY PARTS DRAWING

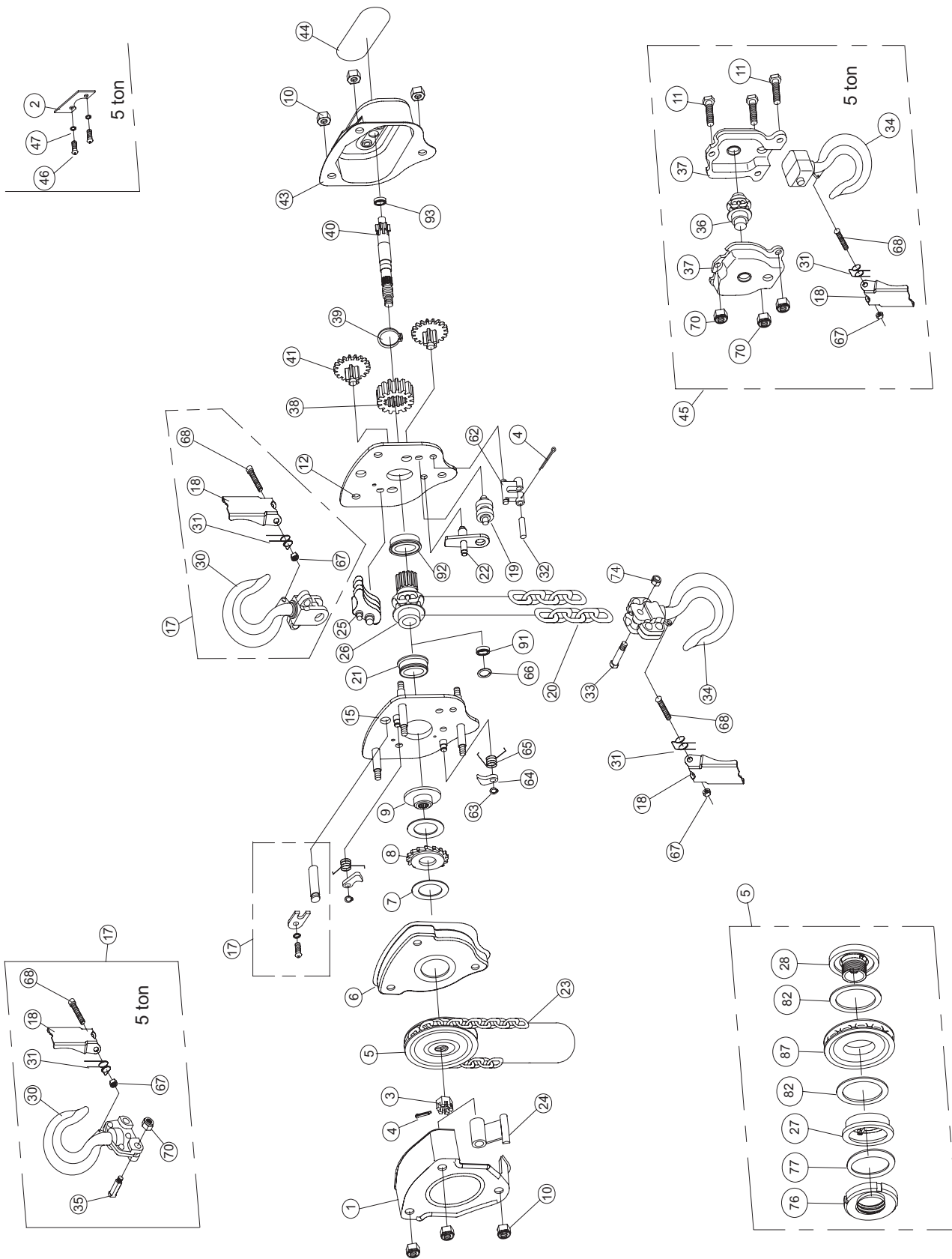

(Dwg. MHP2915)

HOIST ASSEMBLY PARTS LIST

ITEM NO.	DESCRIPTION OF PART	QTY. TOTAL	PART NO.					
			1/2 ton	1 ton	1-1/2 ton	2 ton	3 ton	5 ton
*	Cover Kit (includes items 1, 10 and 43)	1	45593381	45593555	45593811	45593969	45594207	45594363
1	Hand Wheel Cover	1	45593464	45593654	45593894	45594041	45594280	45594553
2	Top Hook Support Plate	1	Order item 17					
3	Nut	1	Order item 75					
4	Cotter Pin	4						
5	Hand Wheel Slip Clutch Assembly (includes items 27, 28, 76, 77, 82 & 87)	1	50002	100002	150002	200002	300002	500002
6	Support Plate	1	Not sold separately					
7	Friction Disc	2	45518826	45518859	45518883	45518891	45518909	45518917
8	Ratchet Disc	1	Order item 75					
9	Brake Hub	1						
10	Nut	6	Not sold separately					
11	Capscrew	3	Order item 45					
12	Side Plate	1	45593415	45593597	45593845	45593993	45594231	45594397
14	Chain Pin Kit (includes items 33 & 74)	1	45519261	45519279	45519287	45519295	45519303	45519311
15	Support Plate	1	45593423	45593613	45593852	45594009	45594249	45594512
17	Top Hook Assembly (includes 18, 30, 31, 35, 67, 68 & 70)	1	45518933	45518941	45518958	45518974	45518982	45518990
18	Latch Kit (includes items 18, 32, 67 & 68)	1	45519006	45519014	45519022	45519030	45519048	45519055
19	Guide Roller	1	45593514	45593704	45593944	45594108	45594330	45594603
20	Load Chain (bulk)	As Req'd	LCCF005	LC618-G10	LCCF015	LCCV020	LC1030-G10	LCCF025
	Bearing Kit (includes items 10, 21, 39 and 92)	1	45593407	45593571	45593837	45593985	45594223	45594389
21	Bearing	1	Not sold separately					
22	Chain Stripper Assembly	1	45593506	45593696	45593936	45594090	45594322	45594595
23	Hand Chain (bulk)	As Req'd	HCSM005ZP					
24	Hand Chain Guide	1	Not sold separately					
25	Chain Guide	1						
26	Load Sheave	1	45593431	45593621	45593860	45594017	45594256	45594520
27	Hub, Back	1	Order item 5					
28	Hub, Front	1						
29	Warning Tag*	1	71301097					
30	Top Hook - 5 ton	1	Order item 17					

* Not Shown

HOIST ASSEMBLY PARTS LIST CONTINUED

ITEM NO.	DESCRIPTION OF PART	QTY. TOTAL	PART NO.					
			1/2 ton	1 ton	1-1/2 ton	2 ton	3 ton	5 ton
31	Spring	1	Not sold separately					
32	Anchor Pin	1						
33	Capscrew	1						
34	Bottom Hook - 5 ton	1	Order item 45					
*	Hardware Kit (includes items 31, 46, 47, 67 and 70)	1	45594611					
35	Shoulder Screw		Not sold separately					
36	Idle Sheave	1						
37	Bottom Block Plate	2						
*	Gear Assembly (includes items 38, 39 and 41)	1	45593399	45593563	45593829	45593977	45594215	45594371
38	Gear	1	45593456	45593647	45593886	45594033	45594272	45594546
39	Retainer Ring	1	Not sold separately					
40	Pinion	1	45593480	45593670	45593910	45594066	45594306	45594579
41	Reduction Gear	2	45593449	45593639	45593878	45594025	45594264	45594538
43	Gear Cover	1	45593472	45593662	45593902	45594058	45594298	45594561
44	Capacity Label	1	45514551	45514569	45514577	45514585	45514593	45514601
45	Bottom Hook Assembly (includes items 18, 31, 33, 34, 36, 37, 67, 68, 70, 74 & 75)	1	45519063	45519071	45519105	45519113	45519121	45519139
46	Capscrew	2	Not sold separately					
47	Washer	2						
62	Anchor Hanger	1	45593498	45593688	45593928	45594082	45594314	45594587
63	Retainer Ring	2	Only available as item 75					
64	Pawl							
65	Pawl Spring							
66	Ring	1	Not sold separately					
67	Locknut	1						
68	Capscrew	1						
70	Locknut	3						
74	Locknut	1						
75	Brake Kit (includes items 3, 4, 8, 9, 63, 64 & 65)	2	45518743	45518750	45518768	45518784	45518792	45518800
76	Adjusting Nut	1	Order item 5					
77	Bevel Spring	1						
82	Friction Disc	1						
87	Hand Chain Wheel	1						
91	Seal	1						
92	Bearing	1	Not sold separately					
93	Bearing	1						

* Not Shown

ACCESSORIES AND KITS PARTS LIST

DESCRIPTION OF PART	PART NO.
Chain Lubricant	LUBRI-LINK-GREEN®

PARTS ORDERING INFORMATION

The use of other than genuine **Ingersoll Rand** replacement parts may adversely affect the safe operation of this product.

When ordering replacement parts, please specify the following:

1. Complete model number and lot number as it appears on the capacity label.
2. Part number(s) and part description(s) as shown in this manual.
3. Quantity required.

The hoist capacity label is located on the gear cover. Example shown is for a 1-1/2 ton **SMB** hoist, model SMB015. Label is shown smaller than actual size.



For your convenience and future reference it is recommended that the following information be recorded.

Hoist Model Number: _____

Hoist Lot Number: _____

Date Purchased: _____

Return Goods Policy

Ingersoll Rand will not accept any returned goods for warranty or service work unless prior arrangements have been made and written authorization has been provided from the location where the goods were purchased.

Hoists returned with opened, bent or twisted hooks, or without chain and hooks, will not be repaired or replaced under warranty.

NOTICE

• **Continuing improvement and advancement of design may cause changes to this hoist which are not included in this manual. Manuals are periodically revised to incorporate changes. Always check the manual edition number on the front cover for the latest issue.**

Disposal

When the life of the hoist has expired, it is recommended that the hoist be disassembled, degreased and parts separated as to materials so that they may be recycled.

For additional information contact:

Ingersoll Rand
 510 Hester Drive
 P.O. Box 618
 White House, TN 37188
 Phone: (615) 672-0321
 Fax: (615) 672-0801

DECLARATION OF CONFORMITY

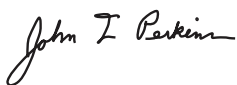
CE	<p>(CS) PROHLÁŠENÍ O SHODĚ (DA) FABRIKATIONSERKLÆRING (DE) KONFORMITÄTSEKTLÄRUNG (EL) ΔΗΛΩΣΗ ΑΝΑΓΝΩΡΙΣΗΣ (ES) DECLARACIÓN DE CONFORMIDAD (FI) VAKUUTUS NORMIEN TÄYTTÄMISESTÄ (FR) CERTIFICAT DE CONFORMITÉ (HU) MEGFELELŐSÉGI NYILATKOZAT (IT) DICHIARAZIONE DI CONFORMITÀ (NL) SCHRIFTELIJKE VERKLARING VAN CONFORMITEIT (NO) KONFORMITETSERKLÆRING (PT) DECLARAÇÃO DE CONFORMIDADE (PL) DEKLARACJA ZGODNOŚCI (SK) PREHLÁŠENIE O ZHODE (SL) IZJAVA O SKLADNOSTI (SV) FÖRSÄKRAN OM ÖVERENSSTÄMMELSE</p>
<p>Ingersoll Rand 529, Avenue Roger Salengro, 59450 Sin Le Noble, France</p>	
<p>Declare under our sole responsibility that the product: Manual Chain Hoist</p>	
<p>(CS) Prohlašujeme na svou zodpovědnost, že produkt: (DA) Erklærer som eneansvarlig, at nedenstående produkt: (DE) Erklären hiermit, gemäß unserer alleinigen Verantwortung, daß die Geräte: (EL) Δηλώνουμε ότι με δική μας ευθύνη το προϊόν: (ES) Declaramos que, bajo nuestra responsabilidad exclusiva, el producto: (FI) Vakuutamme ja kannamme yksin täyden vastuun siitä, että tuote: (FR) Déclarons sous notre seule responsabilité que le produit: (HU) Kizárólagos felelősségünk tudatában kijelentjük, hogy a termék: (IT) Dichiariamo sotto la nostra unica responsabilità che il prodotto: (NL) Verklaren, onder onze uitsluitende aansprakelijkheid, dat het produkt: (NO) Erklærer på ære og samvittighet at produktet: (PL) Przyjmując pełną odpowiedzialność, oświadczamy, że produkt: (PT) Declaramos sob a nossa exclusiva responsabilidade que o produto: (SK) Závazne prehlasujeme, že výrobok: (SL) Pod polno odgovornostjo izjavljamo, da je izdelek: (SV) Intygat enligt vårt ansvar att produkten:</p>	
<p>Model: SMB005, SMB010, SMB015, SMB020, SMB030, SMB050 / Serial Number Range: XXXXC07 and up</p>	
<p>(CS) Model: / Rozsah výrobních čísel: (DA) Model: / Seriennummerområde: (DE) Modell: / Seriennummernbereich: (EL) Μοντέλο: / Κλίμακα σειριακών αριθμών: (ES) Modelo: / Números de serie: (FI) Malli: / Sarjanumeroalue: (FR) Modèle: / Gamme de numéros de série: (HU) Modell: / Gyártási szám-tartomány: (IT) Modello: / Gamma delle matricole: (NL) Model: / Seriennummer: (NO) Modell: / Serien: (PL) Model: / Zakres numerów serii: (PT) Modelo: / Gama de Nos de Série: (SK) Model: / Rozsah výrobních čísel: (SL) Model: / Območje serijskih števil: (SV) Modell: / Seriennummer, mellan:</p>	
<p>To which this declaration relates, is in compliance with provisions of Directive(s): 98/37/EC (machinery)</p>	
<p>(CS) Ke kterým se toto prohlášení vztahuje, odpovídají ustanovením směrnic: (DA) som denne erklæring vedrører, overholder bestemmelserne i følgende direktiv(er): (DE) auf das sich diese Erklärung bezieht, der folgenden Richtlinie entspricht: (EL) στο οποίο αναφέρεται αυτή η δήλωση, πληροί τις διατάξεις της Οδηγίας: (ES) a los que se refiere la presente declaración, cumplen con todo lo establecido en las directivas: (FI) johon tämä vakuutus viittaa, täyttää direktiiveissä: (FR) Objet de ce certificat, est conforme aux prescriptions des Directives: (HU) Amelyekre ezen nyilatkozat vonatkozik, megfelelnek a következő irányelvek előírásainak: (IT) a cui si riferisce la presente dichiarazione è conforme alle normative delle direttive: (NL) waarop deze verklaring betrekking heeft overeenkomt met de bepalingen van directieven: (NO) som denne erklæringen gjelder for, oppfyller bestemmelsene i direktivene: (PL) Którego dotyczy niniejsza deklaracja, jest zgodny z wymogami dyrektyw: (PT) Ao qual se refere a presente declaração, está de acordo com as prescrições das Directivas: (SK) Na ktorý sa toto prehlásenie vzťahuje, je v súlade s ustanoveniami Smernice (Smerníc): (SL) Na katerega se ta izjava o skladnosti nanaša, v skladu z določili smernic: (SV) Som detta intyg avser, överensstämmer med följande direktiv:</p>	
<p>By using the following Principle Standards: EN 292; VBG 9a</p>	
<p>(CS) Použitím následujících zákonných norem: (DA) ved at være i overensstemmelse med følgende hovedstandard(er): (DE) Unter Anlehnung an die folgenden Grundnormen entsprechen: (EL) Χρησιμοποιώντας τα παρακάτω κύρια πρότυπα: (ES) conforme a los siguientes estándares: (FI) esitetty vaatimukset seuraavia perusnormeja käytettäessä: (FR) En observant les normes de principe suivantes: (HU) A következő elvi szabványok alkalmazása mellett: (IT) Seguendo i principi standard indicati di seguito: (NL) overeenkomstig de volgende hoofdstandaards: (NO) Ved å bruke følgende prinsipielle standarder: (PL) Spełniając wymogi następujących głównych norm: (PT) observando as seguintes Normas Principais: (SK) Pri dodržaní nasledovných noriem: (SL) Uporabljeni osnovni standardi: (SV) Genom att använda följande principstandard:</p>	
<p>Date: February, 2007</p>	
<p>(CS) Datum: Únor 2007: (DA) Dato: Februar, 2007: (DE) Datum: Februar, 2007: (EL) Ημερομηνία: Φεβρουάριος, 2007: (ES) Fecha: Febrero, 2007: (FI) Päiväys: Helmikuu, 2007: (FR) Date: Février, 2007: (HU) Dátum: 2007 Február: (IT) Data: Febbraio, 2007: (NO) Dato: Februar, 2007: (NL) Datum: Februari, 2007: (PT) Data: Fevereiro, 2007: (PL) Data: luty 2007: (SK) Dátum: Február 2007: (SL) Datum: februar 2007: (SV) Datum: Februari, 2007:</p>	
<p>Approved By:</p>	
<p>(CS) Schválil: (DA) Godkendt af: (DE) Genehmigt von: (EL) Εγκρίθηκε από: (ES) Aprobado por: (FI) Hyväksytty: (FR) Approuvé par: (HU) Jóváhagyta: (IT) Approvato da: (NL) Goedgekeurd door: (NO) Godkjent av: (PL) Zatwierdzone przez: (PT) Aprovado por: (SK) Schválil: (SL) Odbрил: (SV) Godkánt av:</p>	
	
<p>John T. Perkins - IREP - Annandale, New Jersey USA Engineering Manager</p>	

WARRANTY

LIMITED WARRANTY

Ingersoll Rand Company warrants to the original user its Hoists and Winches (Products) to be free of defects in material and workmanship for a period of one year from the date of purchase.

Ingersoll Rand will repair, without cost, any Product found to be defective, including parts and labor charges, or at its option, will replace such Products or refund the purchase price less a reasonable allowance for depreciation, in exchange for the Product. Repairs or replacements are warranted for the remainder of the original warranty period.

If any Product proves defective within its original one year warranty period, it should be returned to any Authorized Hoist and Winch Service Distributor, transportation prepaid with proof of purchase or warranty card.

This warranty does not apply to Products which **Ingersoll Rand** has determined to have been misused or abused, improperly maintained by the user, or where the malfunction or defect can be attributed to the use of non-genuine **Ingersoll Rand** parts.

Ingersoll Rand makes no other warranty, and all implied warranties including any warranty of merchantability or fitness for a particular purpose are limited to the duration of the expressed warranty period as set forth above. **Ingersoll Rand**'s maximum liability is limited to the purchase price of the Product and in no event shall **Ingersoll Rand** be liable for any consequential, indirect, incidental, or special damages of any nature rising from the sale or use of the Product, whether based on contract, tort, or otherwise.

Note: Some states do not allow limitations on incidental or consequential damages or how long an implied warranty lasts so that the above limitations may not apply to you.

This warranty gives you specific legal rights and you may also have other rights which may vary from state to state.

IMPORTANT NOTICE

It is our policy to promote safe delivery of all orders.

This shipment has been thoroughly checked, packed and inspected before leaving our plant and receipt for it in good condition has been received from the carrier. Any loss or damage which occurs to this shipment while enroute is not due to any action or conduct of the manufacturer.

Visible Loss or Damage

If any of the goods called for on the bill of lading or express receipt are damaged or the quantity is short, do not accept them until the freight or express agent makes an appropriate notation on your freight bill or express receipt.

Concealed Loss or Damage

When a shipment has been delivered to you in apparent good condition, but upon opening the crate or container, loss or damage has taken place while in transit, notify the carrier's agent immediately.

Damage Claims

You must file claims for damage with the carrier. It is the transportation company's responsibility to reimburse you for repair or replacement of goods damaged in shipment. Claims for loss or damage in shipment must not be deducted from the **Ingersoll Rand** invoice, nor should payment of **Ingersoll Rand** invoice be withheld awaiting adjustment of such claims as the carrier guarantees safe delivery.

You may return products damaged in shipment to us for repair, which services will be for your account and form your basis for claim against the carrier.

